

# D625MW General Specification.

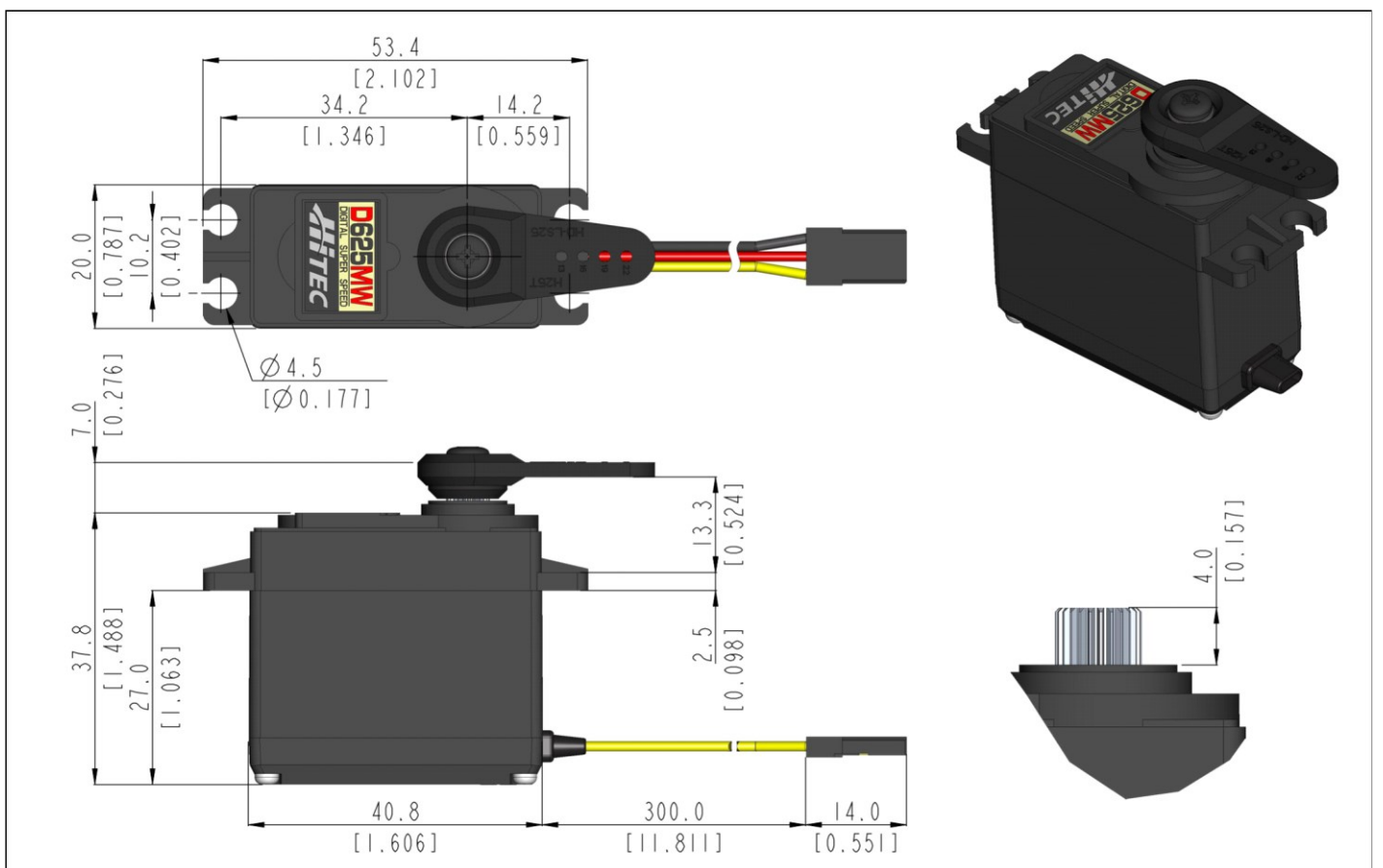

Control System	PWM/TTL(Half Duplex)			-
Position Sensor Type	Contact Analog Potentiometer			-
Motor Type	Cored Metal Brush			At the Max voltage, it is recommended to be used only for a short time duration.
Operating Voltage Range	3.5 ~ 8.4V			
Voltage	4.8V	6.0V	7.4V	At 25°C(±10%), 45%RH(±10%) <u>measurement environment</u>
No Load Speed	0.20sec/60°	0.15sec/60°	0.13sec/60°	
Stall Torque	6.3kgf-cm (87.49oz-in)	8.8kgf-cm (122.21oz-in)	10.0kgf-cm (138.87oz-in)	
Peak Efficiency Torque	1.3kgf-cm (17.5 oz-in)	1.8kgf-cm (24.44oz-in)	2.0kgf-cm (27.77oz-in)	
Standing Current	30mA	30mA	30mA	
No Load Running Current	300mA	400mA	500mA	
Stall Current	1,700mA	2,150mA	2,650mA	
Deadband	2μs	2μs	2μs	
Operating Travel	Default: ±60°, Programmable: Max 175° / Pulse Width: 900~2100μs(Center:1500μs)			-
Continuous Rotation	n/a			-
Operating Temperature Range	-20°C ~ +60°C (-4°F ~+140°F)			-
Storage Temperature Range	-30°C ~ +80°C (-22°F ~+176°F)			-
Connector Wire Length	300mm (11.811inch)			
Connector Wire Gauge	22AWG			
Dimensions	40.8mm x 20.0mm x 37.8mm (1.606inch x 0.787inch x 1.488inch)			General Tolerance ±0.1mm
Weight	60.0g (2.116oz)			Excluding the weight of Horn
Bearing Type	2 Ball Bearing			-
Case Material	Engineering Plastic			-
Gear Material	1 Metal-Plastic & 3 Metal Gears			-
Gear Train Backlash	Max 0.5°			-
Horn Gear Spline	25T(Ø6)			-
IP-Rating	IP4X			-
Servo Amplifier Type	32bit programmable Digital			-



1:1 scale (Unit : mm[inch])

- This product should not be used directly on the human body for medical purposes.
- This product should not be used for war weapons.
- All specifications are subject to change without notice.

