

# D980TW General Specification.

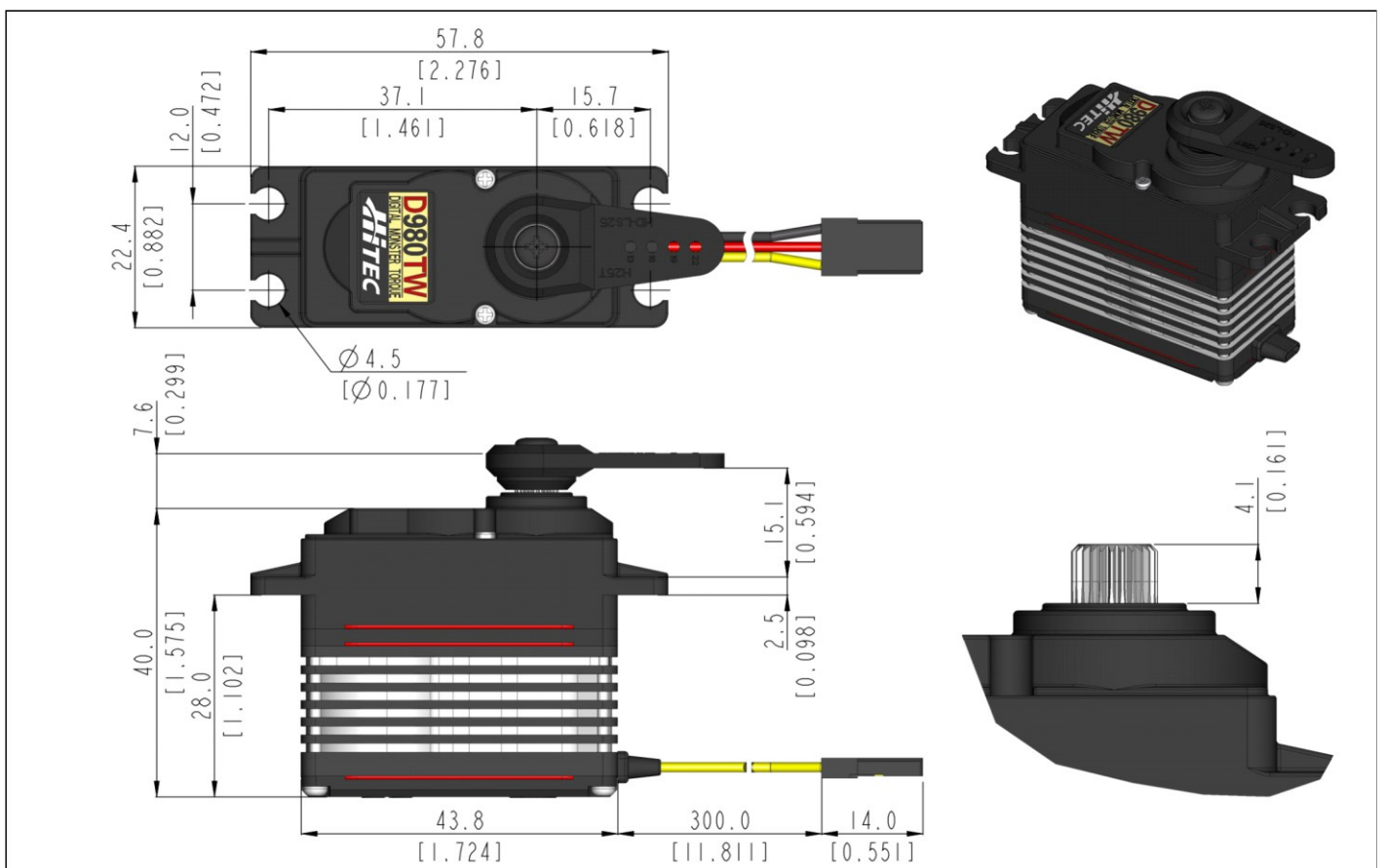

Control System	PWM/TTL(Half Duplex)			-
Position Sensor Type	Contact Analog Potentiometer			-
Motor Type	Coreless			At the Max voltage, it is recommended to be used only for a short time duration.
Operating Voltage Range	3.5 ~ 8.4V			
Voltage	4.8V	6.0V	7.4V	At 25°C(±10%), 45%RH(±10%) <u>measurement environment</u>
No Load Speed	0.28sec/60°	0.21sec/60°	0.17sec/60°	
Stall Torque	26.0kgf-cm (361.07oz-in)	36.0kgf-cm (499.95oz-in)	44.0kgf-cm (611.05oz-in)	
Peak Efficiency Torque	5.2kgf-cm (72.21oz-in)	7.2kgf-cm (99.99oz-in)	8.8kgf-cm (122.21oz-in)	
Standing Current	30mA	30mA	30mA	
No Load Running Current	300mA	390mA	500mA	
Stall Current	4,200mA	4,800mA	6,200mA	
Deadband	1μs	1μs	1μs	
Operating Travel	Default: ±60°, Programmable: Max 175° / Pulse Width: 900~2100μs(Center:1500μs)			-
Continuous Rotation	n/a			-
Operating Temperature Range	-20°C ~ +60°C (-4°F ~ +140°F)			-
Storage Temperature Range	-30°C ~ +80°C (-22°F ~ +176°F)			-
Connector Wire Length	300mm (11.811inch)			
Connector Wire Gauge	20AWG			
Dimensions	43.8mm x 22.4mm x 40.0mm (1.724inch x 0.882inch x 1.575inch)			General Tolerance ±0.1mm
Weight	78.2g (2.758oz)			Excluding the weight of Horn
Bearing Type	2 Ball Bearing			-
Case Material	Engineering Plastic & Aluminum Heat Sink			-
Gear Material	1 Metal-Plastic & 3 Titanium Alloy Gears			-
Gear Train Backlash	Max 0.5°			-
Horn Gear Spline	25T(Ø6)			-
IP-Rating	IP54			-
Servo Amplifier Type	32bit programmable Digital			-



1:1 scale (Unit : mm[inch])

- This product should not be used directly on the human body for medical purposes.
- This product should not be used for war weapons.
- All specifications are subject to change without notice.

