

HS-755HB General Specification.

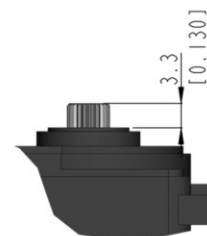

Control System	PWM			-
Position Sensor Type	Contact Analog Potentiometer			-
Motor Type	Cored Metal Brush			At 25°C(±10%), 45%RH(±10%) <u>measurement environment</u>
Operating Voltage Range	4.8 ~ 6.0V			
Voltage	4.8V	6.0V	-	
No Load Speed	0.28sec/60°	0.23sec/60°	-	
Stall Torque	11.0kgf-cm (152.76oz-in)	13.2kgf-cm (183.31oz-in)	-	
Peak Efficiency Torque	2.2kgf-cm (30.6 oz-in)	2.6kgf-cm (36.1 oz-in)	-	
Standing Current	8mA	8mA	-	
No Load Running Current	230mA	250mA	-	
Stall Current	1,500mA	1,800mA	-	
Deadband	5μs	5μs	-	
Operating Travel	Default: ±60°, Non-programmable / Pulse Width: 900~2100μs(Center:1500μs)			-
Continuous Rotation	n/a			-
Operating Temperature Range	-20°C ~ +60°C (-4°F ~+140°F)			-
Storage Temperature Range	-30°C ~ +80°C (-22°F ~+176°F)			-
Connector Wire Length	300mm (11.811inch)			
Connector Wire Gauge	22AWG			
Dimensions	59.0mm x 29.0mm x 50.0mm (2.323inch x 1.142inch x 1.969inch)			General Tolerance ±0.1mm
Weight	110.0g (3.880oz)			Excluding the weight of Horn
Bearing Type	2 Ball Bearing			-
Case Material	Engineering Plastic			-
Gear Material	4 Heavy Duty Resin Gears			-
Gear Train Backlash	Max 0.5°			-
Horn Gear Spline	24T(Ø6)			-
IP-Rating	IP54			-
Servo Amplifier Type	Analog Contorller			-

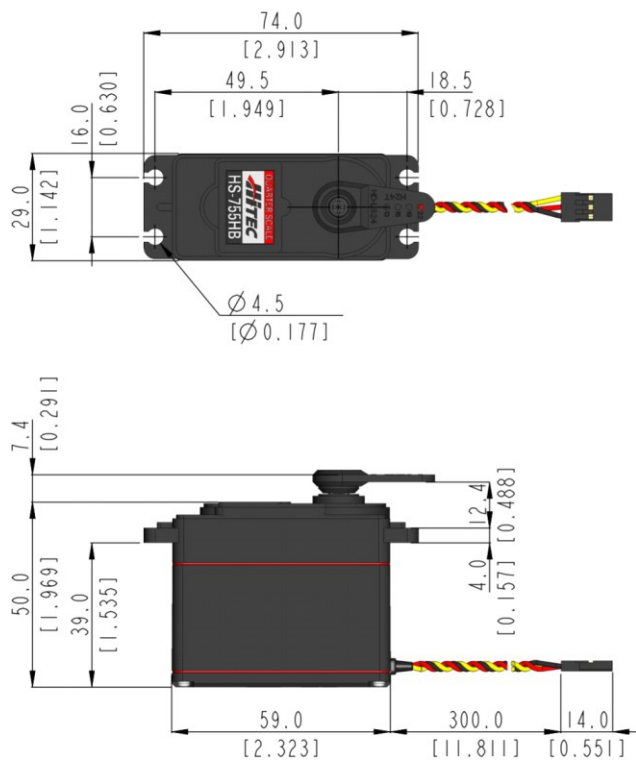

1:2 scale (Unit : mm[inch])

- This product should not be used directly on the human body for medical purposes.
- This product should not be used for war weapons.
- All specifications are subject to change without notice.

