

HS-7950TH General Specification.

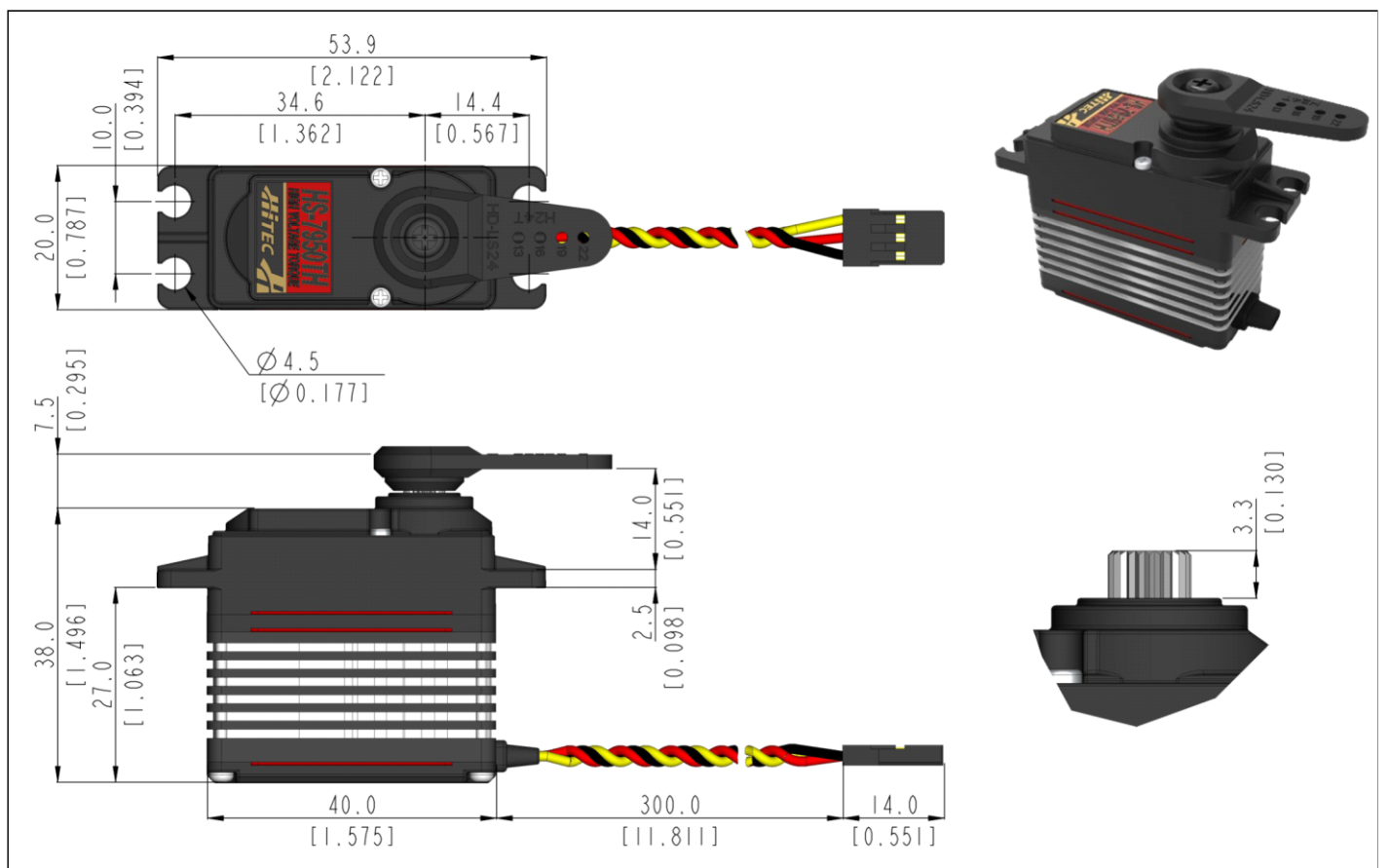

Control System	PWM		-
Position Sensor Type	Contact Analog Potentiometer		-
Motor Type	Coreless		At the Max voltage, it is recommended to be used only for a short time duration.
Operating Voltage Range	3.5 ~ 8.4V		
Voltage	-	6.0V	7.4V
No Load Speed	-	0.15sec/60°	0.13sec/60°
Stall Torque	-	29.0kgf-cm (402.7 oz-in)	35.0kgf-cm (486.1 oz-in)
Peak Efficiency Torque	-	5.8kgf-cm (80.5 oz-in)	7.0kgf-cm (97.2 oz-in)
Standing Current	-	10mA	10mA
No Load Running Current	-	390mA	500mA
Stall Current	-	4,800mA	6,200mA
Deadband	-	1μs	1μs
Operating Travel	Default: ±60°, Programmable: Max 175° / Pulse Width: 900~2100μs(Center:1500μs)		Based on resolution normal mode
Continuous Rotation	n/a		-
Operating Temperature Range	-20°C ~ +60°C (-4°F ~ +140°F)		-
Storage Temperature Range	-30°C ~ +80°C (-22°F ~ +176°F)		-
Connector Wire Length	300mm (11.811inch)		 <ul style="list-style-type: none"> 1. SIGNAL 2. VCC 3. GND
Connector Wire Gauge	20AWG		
Dimensions	40.0mm x 20.0mm x 38.0mm (1.575inch x 0.787inch x 1.496inch)		General Tolerance ±0.1mm
Weight	68.0g (2.399oz)		Excluding the weight of Horn
Bearing Type	2 Ball Bearing		-
Case Material	Engineering Plastic & Aluminum Heat Sink		-
Gear Material	1 Metal-Plastic & 3 Titanium Alloy Gears		-
Gear Train Backlash	Max 0.5°		-
Horn Gear Spline	24T(Ø6)		-
IP-Rating	IP54		-
Servo Amplifier Type	8bit Programmable Digital		-



1:1 scale (Unit : mm[inch])

- This product should not be used directly on the human body for medical purposes.
- This product should not be used for war weapons.
- All specifications are subject to change without notice.

